



DSP88 8 IN / 8 OUT DSP PROCESSOR

Owners Manual

China Patent : ZL2015 1 0464611.6
USA Patent : US9733890 B2



Congratulations, you have just purchased the finest Motorcycle Audio products on the market today. Cicada Audio products represent the latest advances in acoustic technology in sound reproduction for your Motorcycle applications. Cicada Audio products are designed, developed, and engineered using the latest innovative materials and components to provide the finest sound reproduction possible. Every Cicada Audio product has been Klippel verified and tested to ensure the best sounding and most reliable product on the market, if installed properly, Cicada Audio products will provide many years of the ultimate listening experience.

Please note that prolonged exposure to sound pressure levels in excess of 100dB can cause permanent hearing loss. Using Cicada Audio products can exceed that level so please exercise restraint in its operation in order to preserve your ability to enjoy its high fidelity sound for many years to come.

Cicada Audio recommends our products be professionally installed by an authorized Cicada Audio dealer to achieve the best possible system recommendation and installation. This will ensure a true Cicada Audio listening experience and sound you would expect from Cicada Audio products. In doing this you will extend your warranty from one year to two years.

DSP88 - 8 INPUT / 8 OUTPUT DSP PROCESSOR

What comes in the package

- (1) Mounting - Double Stick Bottom
- (1) 8 Channel INPUT High Level RCA Input Harness
- (1) 4 Channel INPUT Lo Level SPEAKER Input with HD Molex Harness
- (1) 8 Channel OUTPUT High Level RCA Output Harness

DSP88

8 IN / 8 OUT DSP PROCESSOR

- Signal Input: 8 High-Low Level Inputs
- Signal Output: 8 RCA Outputs
- Output Impedance: 200 Ohms
- Frequency Response: 20Hz – 20kHz +/- 0.5dB
- Input Voltage: 0.02V – 12V
- Input Impedance: 20k Ohms
- Output Voltage: Up to 8V
- THD+N: <1.0%
- Signal-to-Noise: >100 dBA (A-weighted)
- Digital Signal Processing (DSP):
Speed: 147 MIPS Precision: 32-Bit Accumulators: 72-bit
- Digital to Analog (DAC): Precision: 24-Bit
- Dynamic Range: 108 dB
- Digital to Analog (DAC): Precision: 24-Bit
- Dynamic Range: 108 dB
- THD+N: -98 dB
- Analog to Digital (ADC): Precision: 24-Bit
- Dynamic Range: 105 dB
- THD+N: -98 dB
- Operating Voltage: 9 – 16 VDC
- Crossover Frequency: Variable: 20 Hz to 10 kHz
- Crossover Slope: Selectable Slope: 6/12/18/24/36/48 dB/Octave
- EQ Frequency Controls: Selectable Q: 0.05 to 20.0
- Dimensions (H x W x D):
1.26" x 4.04" x 5.12" (32 mm x 102.5 mm x 130 mm)

NOTE: there is a FULL "Plug & Play harness kit available from your local Cicada Audio retailer or from our website

WWW.CICADAAUDIO.COM

INPUT CONFIGURATION

OUTPUT CONFIGURATION

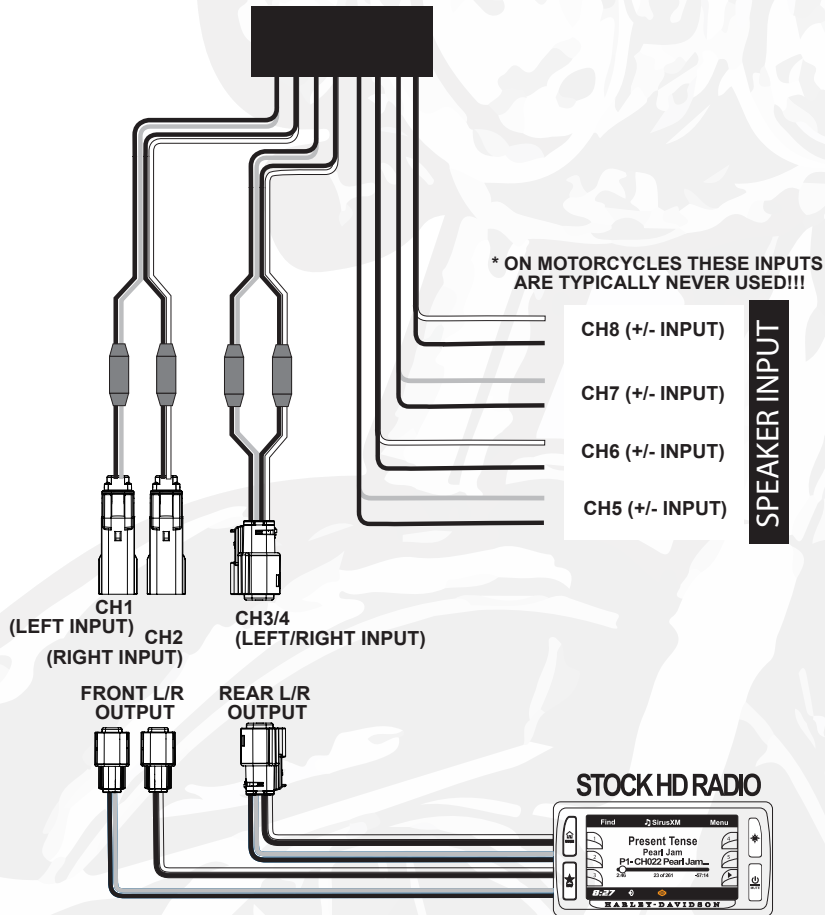
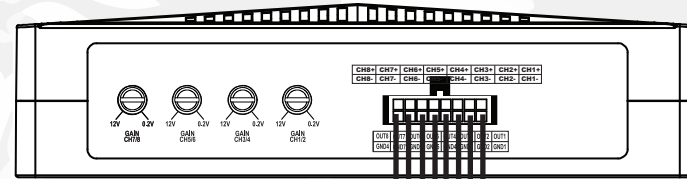
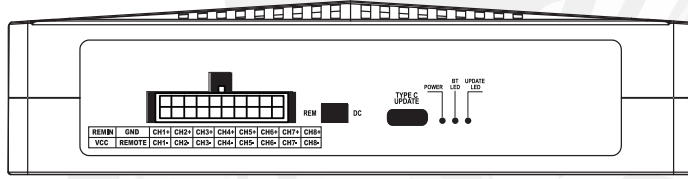

Stock HD radio and wiring used!
No need to cut anything

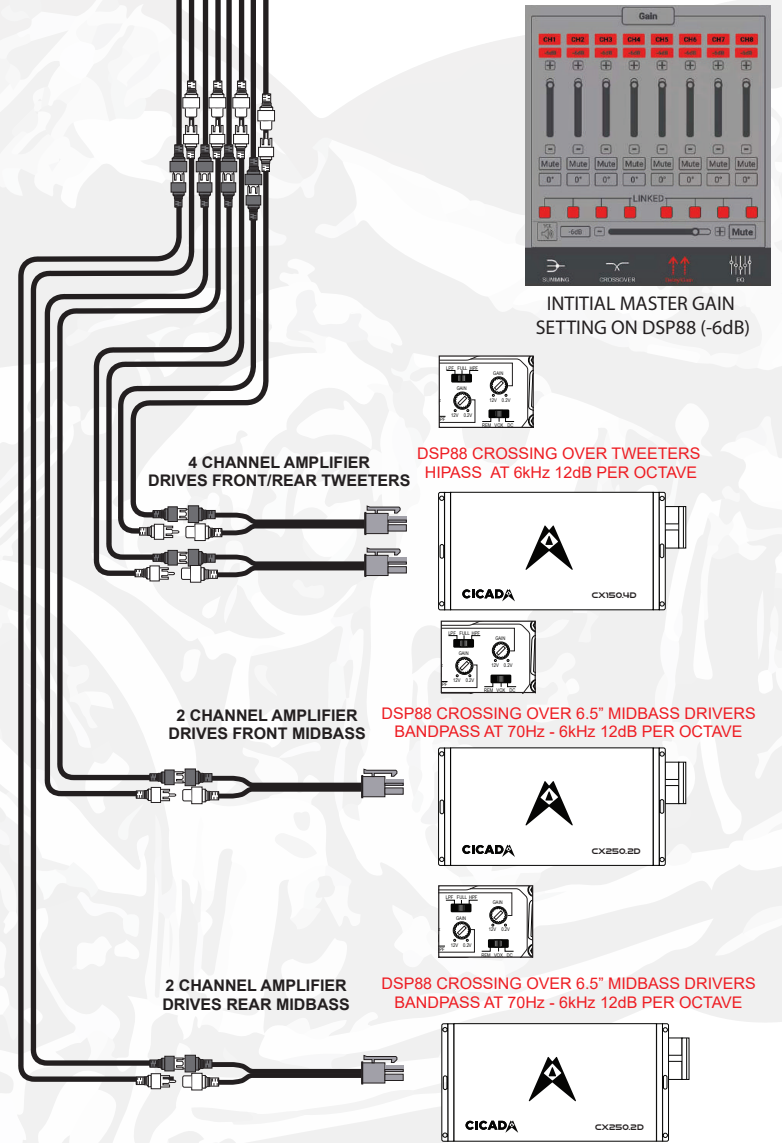



INPUT

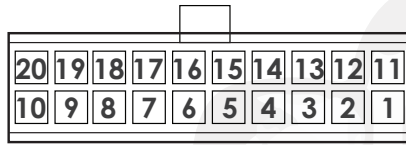

(looking into wired end)

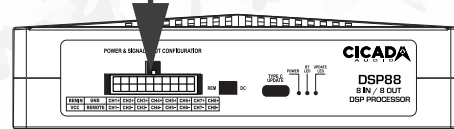

Pin	Wire	Function	Pin	Wire	Function
1	Black	CH8 (-)	11	Blue	CH8 (+)
2	Black	CH7 (-)	12	Blue	CH7 (+)
3	Black	CH6 (-)	13	Blue	CH6 (+)
4	Black	CH5 (-)	14	Blue	CH5 (+)
5	Black	CH3 (-)	15	Blue	CH4 (+)
6	Black	CH3 (-)	16	Blue	CH3 (+)
7	Black	CH2 (-)	17	Blue	CH2 (+)
8	Black	CH1(-)	18	Blue	CH1(+)
9	Blue	REM Out	19	Red	REM In
10	Black	Ground	20	Yellow	B+ Constant

OUTPUT

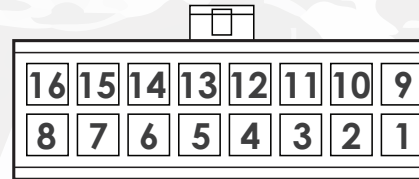
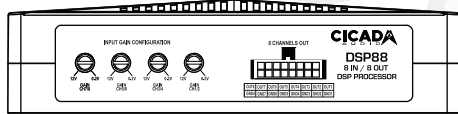

Pin	Wire	Function	Pin	Wire	Function
1	Black	CH8 (-)	9	Blue	CH8 (+)
2	Black	CH7 (-)	10	Blue	CH7 (+)
3	Black	CH6 (-)	11	Blue	CH6 (+)
4	Black	CH5 (-)	12	Blue	CH5 (+)
5	Black	CH3 (-)	13	Blue	CH4 (+)
6	Black	CH3 (-)	14	Blue	CH3 (+)
7	Black	CH2 (-)	15	Blue	CH2 (+)
8	Black	CH1 (-)	16	Blue	CH1(+)

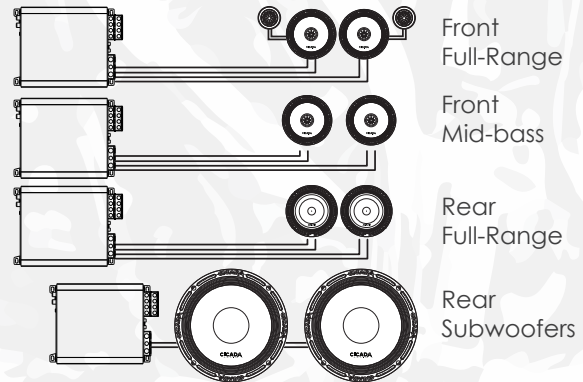
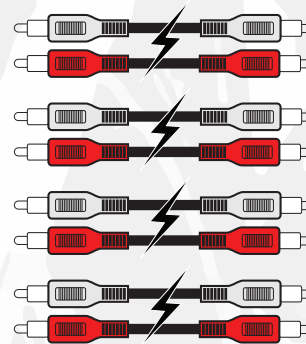
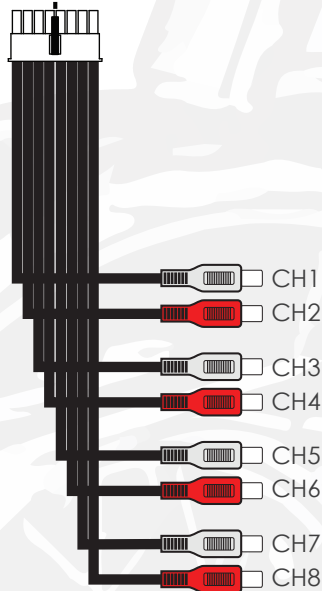



DIMENSIONAL DRAWINGS FOR FITMENT

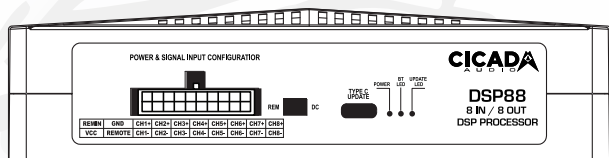
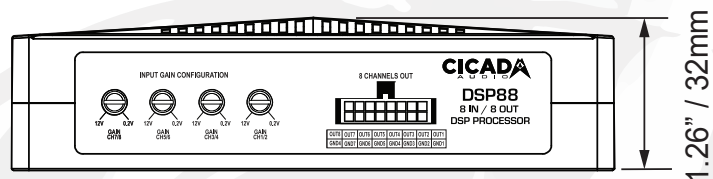
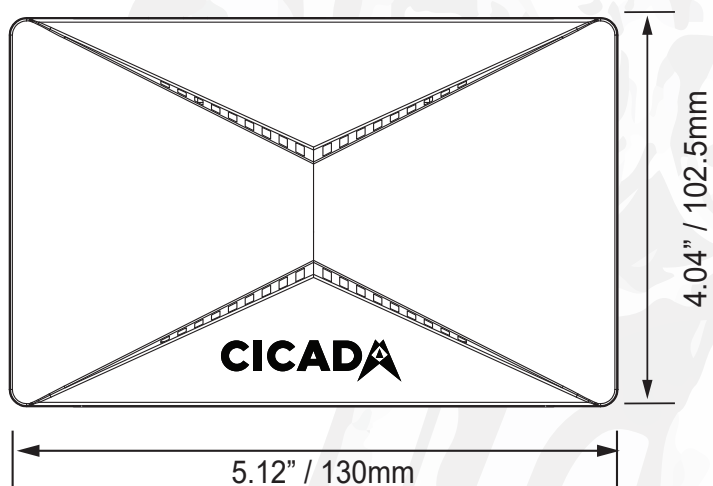

- ① **PWR/PRT LED** - This light indicate when the amplifier is powered up normally and when there is a protection fault. The Protect LED is illuminated when there is a problem with your amplifier. Please contact your authorize Cicada Audio dealer or call Cicada Audio's technical support.
- ② **GAIN (Input Gain Adjustment)** - This control matches the preamp INPUT stage of the Cicada Audio amplifier to your source unit. This is NOT a volume control. The range is between approximately 200mV and 10V. It can ALSO handle speaker inputs of less than 25 watts RMS (typical OEM headunits are LESS than 25 W RMS,...but NOT all)
- ③ **TURN-ON OPTIONS** - The Cicada Audio DSP88 can be switched on and off using one of two methods, determined by the position of the amplifier's "Turn-On Mode" switch. Please read the "Set-Up " portion of this guide and determine which is best suited for your specific system. NOTE: DC and VOX turn-on settings ONLY work with speaker level input.
- ④ **USB C** - Input for connecting a PC to use ONLY for updating Firmware. ONLY!!!
- ⑤ **BlueTooth® Dongle** - (Plug in) This makes it so the DSP125.4D can be programmed by phone or tablet for all DSP tuning.
- ⑥ **Front RCA Input Terminal (CH1 /2)** - The RCA jacks allow for a normal Left and Right channel signal input. Simply connect to the source unit using RCA type audio cables, keeping them away from power wiring wherever possible to reduce risk of noise. NOTE: This input can be used for "speaker level" input by using the optional Speaker Hanress HDFIM/HDRIM (with load resistors), or by simply cutting and attaching OEM head unit speaker outputs to these wires. Or cut up an old RCA cable and connect your HD radio speaker wires that way (Better solution)
- ⑦ **Rear RCA Input Terminal (CH3 /4)** - The RCA jacks allow for a normal Left and Right channel signal input. Simply connect to the source unit using RCA type audio cables, keeping them away from power wiring wherever possible to reduce risk of noise. NOTE: This input can be used for "speaker level" input by using the optional Speaker Hanress HDFIM/HDRIM (with load resistors), or by simply cutting and attaching OEM head unit speaker outputs to these wires.
- ⑧ **RCA Output Terminal** - The RCA jacks allow for a pre amp level CH5/6 output to create a 6 channel system. Which could be subwoofers or midbass or full range drivers
- ⑨ **Front Speaker Output Terminal** - Connect your Front speakers to these wires. Stereo connections are connected as labeled. Bridged connections use the LEFT + and RIGHT - as the two connections. The 2 and 4 channel amplifiers will perform into 2 Ohm stereo loads or 4 Ohm bridged loads. DO NOT run 2 Ohm bridged loads on AND Cicada Audio amplifiers. They will work, but will over heat very quickly.
- ⑩ **Rear Speaker Output Terminal** - Connect your Rear speakers to these wires. Stereo connections are connected as labeled. Bridged connections use the LEFT + and RIGHT - as the two connections. The 2 and 4 channel amplifiers will perform into 2 Ohm stereo loads or 4 Ohm bridged loads. DO NOT run 2 Ohm bridged loads on AND Cicada Audio amplifiers. They will work, but will over heat very quickly.
- ⑪ **Power Input Connections** - These connections are for input power(12V), chassis ground (GRD), and remote(REM) turn-on. Use a minimum of 8 gauge wiring for power and ground connections. The terminals will handle up to 8 gauge wiring with no problem what so ever. Be sure any wiring that passes through metal has a grommet!



Your Bluetooth device (Phone, Tablet, etc.) must support the A2DP Bluetooth profile (commonly known as stereo audio profile) to work with the CA-AMP app. Many of the latest mobile Phones and Tablets with built-in Bluetooth functionality will support this profile. For accurate information about your product, please refer to your Bluetooth device's user manual for details on the Bluetooth profiles it supports and on how to set the device's Bluetooth pairing/searching/setup mode

Make sure to download the App for your phone or tablet



NOTE: CURRENTLY MY APPS DO NOT WORK WITH ANDROID OS12! DO NOT UPGRADE!!!

ABOUT PAIRING VS LINKING

Pairing is the term used when wirelessly connecting two Bluetooth devices for the first time. This allows the devices to "see" each other and creates a unique lasting connection between the specific devices to pass audio. You do NOT need to PAIR your DSP88 as it will NOT BT music on its on. BT is only for setup!!!! You will LINK up to the CA DSP app,NOT PAIR

1. Open the CA DSP app you downloaded to your phone. IF you have set up your phone to "see" all bluetooth around you.... it will see the CA DSP (as long as it is powered up!!)

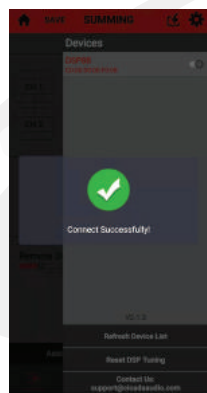

- 2. Once you opened the CA DSP software it will look for your phone. It should "Pop up" Connect Successfully AS shown to the left.
- 3. IF the CA DSP software is open and does NOT show the Connect Successfully Green DOT, then tap the ⚙️ at the top right and the Devices widow opens up. The DSP88 C0:00:00:F0:C? should show up. Slide the right button over to the right to lock it on

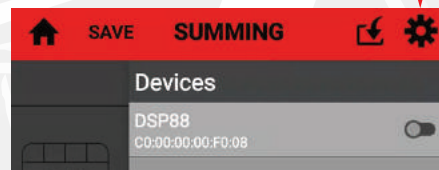

4. You're IN! Now everytime you open the CA DSP app it will say "Connect Successfully" with the GREEN dot with the check in the middle of it.

MAKE SURE YOU ARE CONNECTED BEFORE DOING ANY SETUP CHANGES!!!!

5) Pairing remains intact when the DSP88 and/or the Bluetooth® device is powered off or is taken out of link range (30 feet). To re-establish an active connection when your Bluetooth device returns within range, simple turn off and turn on the DSP88.

6) The next time the DSP88 is powered on it will automatically try to re-establish a link with the most recently linked Bluetooth® device. If your device does not support auto-linking OR was not the last linked to the DSP88, you must re-link manually by selecting DSP88 from the Bluetooth® device's menu on your Bluetooth® device.

7) MAKE SURE ALL NOTIFICATIONS AND SOUNDS ARE TURNED OFF on you Phone or Tablet!!! Otherwise during setup if someone texts or calls you..it will scare you how loud it is!!! So TURN it ALL off.

NOTE: BlueTooth® functionality is limited to the SetUp DSP application - CA DSP NOT for playing audio!! You'll need some kind of source unit (like the stock HD HeadUnit)!

REMEMBER: With ANY DSP I HIGHLY recommend that you willget an RTA to REALLY setup your system. Especially the EQUALIZER part of your setup. There are many available and relatively cheaply.

Our favorite is Audio Tools software (see below) AVAILABLE ONLY ON APPLE! Make sure to buy the APP (Typically \$5.00) as you MUST slow down the RTA for "time Averaging". I recommend 3s to 6s Decay. You dont absolutely need an RTA, BUT It makes life much easier and setup much faster. Your call.

(Not my motorcycle..... so I don't have "dog in this hunt"! Hey I call 'em the way I see 'em!!)



First thing to do BEFORE anything is to decide on what system you are building? Good news is you are using a 8 channel DSP that can handle RCA (pre amp level) or Speaker Level input.

So you can do ALOT!. You have to plan you work and work your plan!!! Trust me it makes it way easier if you have and "end goal" in mind. As mentioned it is a 8 channel DSP with 8 channels you can deal with - at least digitally.

SO LETS DECIDE ON WHAT EXACTLY YOU ARE BUILDING - HERE ARE SOME SYSTEM IDEAS TO LOOK AT. THIS IS SOME SYSTEM IDEAS YOU CAN DO WITH THE DSP88 AND MULTIPLE AMPLIFIER CHANNELS. LOTS OF WHYS TO ROLL!!!



8 CHANNEL / 3 AMP SYSTEM W / COMPONENT & HORNS / WOOFERS

**3 AMPLIFIERS /BI-AMPED
2 - 4 CHANNEL / 1 - 2 CHANNEL**

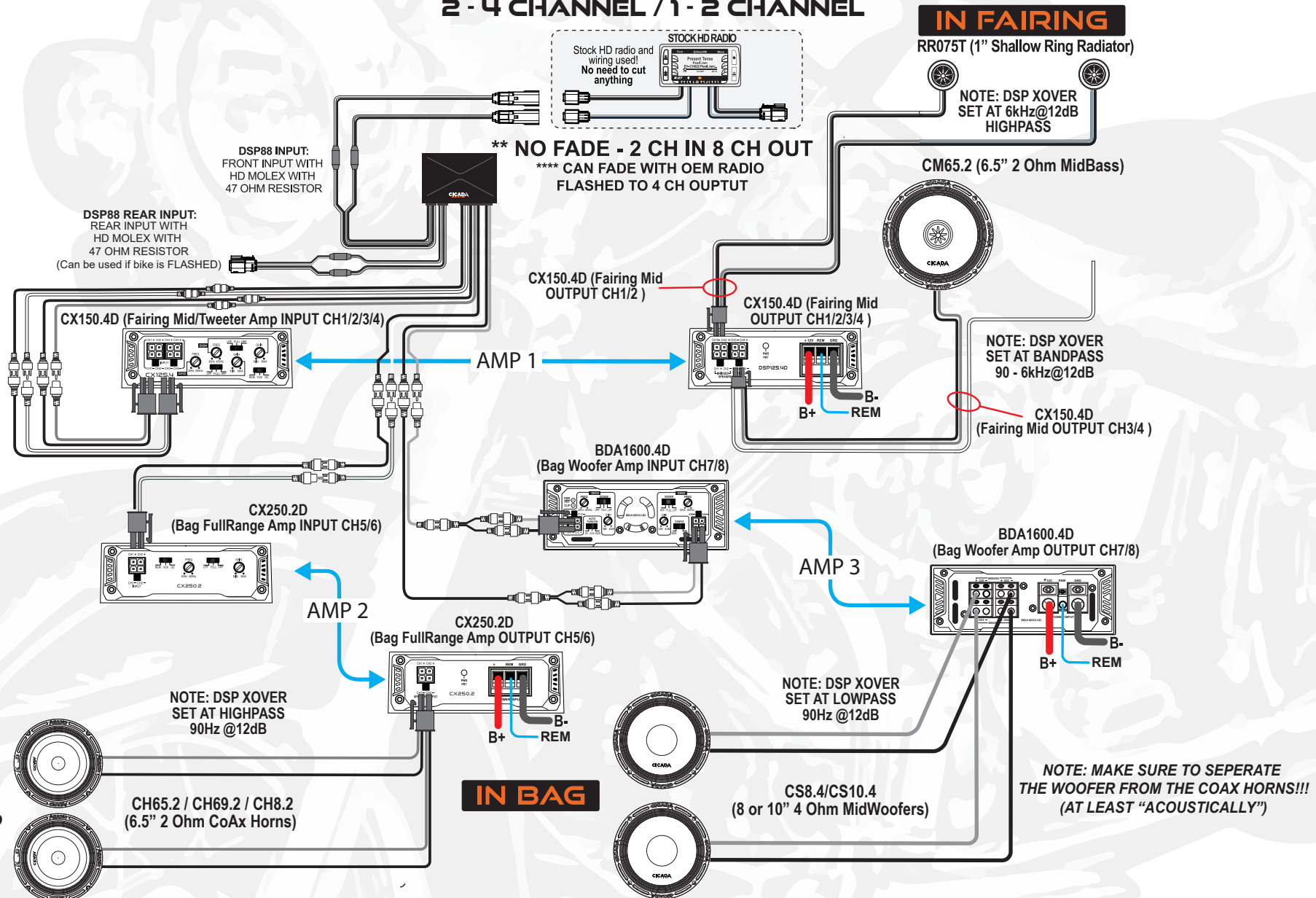



8 CHANNEL / 3 AMP SYSTEM W / COMPONENT & HORNS / NO WOOFERS

3 AMPLIFIERS / BI-AMPED
2 - 2 CHANNEL / 1 - 4 CHANNEL

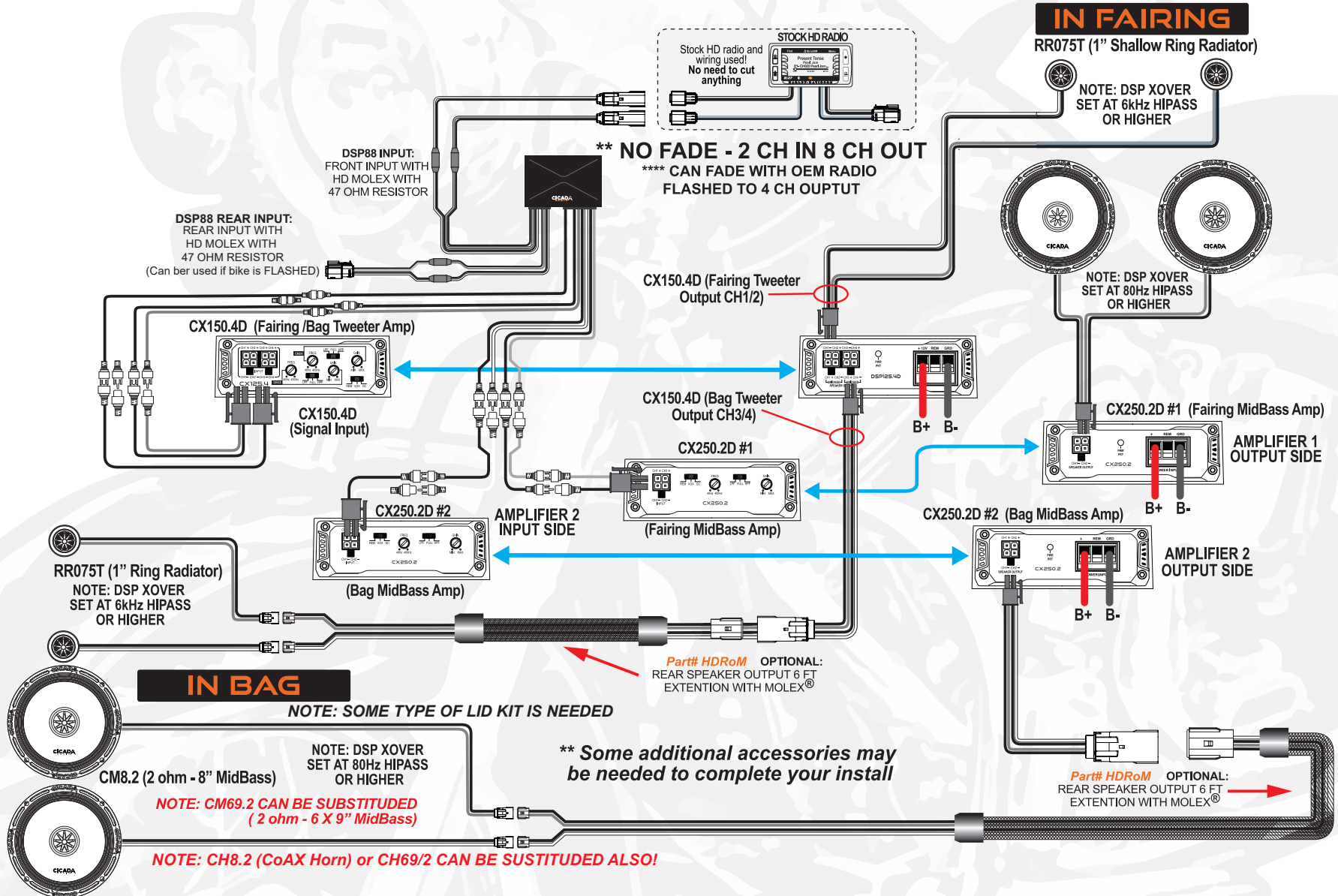

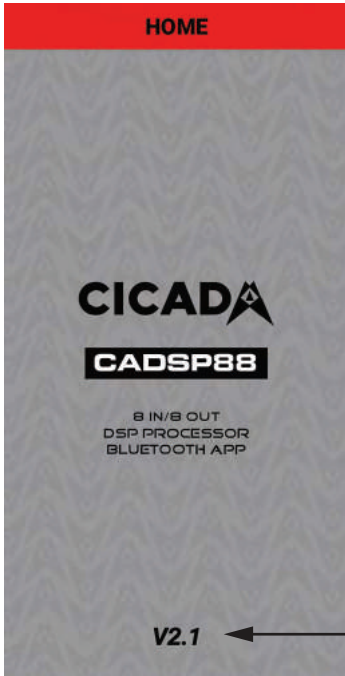

SPECIAL NOTE: All "PreSetup" is done with the amplifier(s) OFF!! (or speakers disconnected)

HOME PAGE:
This is just the beginning, and tell you that you amplifier is a 4 channel amplifier with a 6 channel processor BUILT IN!
Too cool!!!!

NOTE: Software version!!!

Hitting the "🏠" link takes you back to the "Start" page where you "TAP" the screen to go back to the SUMMING page. From there you can go to all setup pages.

SUMMING PAGE:

Depending on your head unit (Stock HD or aftermarket) determines what you select here. If your bike is NOT flashed and your stock bike started out with just fairing speakers and your adding bags, then you'll want to choose CUSTOM

As that is the Output/Input selection, you can still get ALL Channels to work off of ONLY 2 channels of input. Just call CH1 - LEFT ...Then click Ch1 output to CH1 Input. And then continue to click CH1 to CH's 3/5/7 (as shown to the right). Do the same with Ch2, call it RIGHT and then 4/6/8 is paralalled. Again look at the SUMMING page to the right.

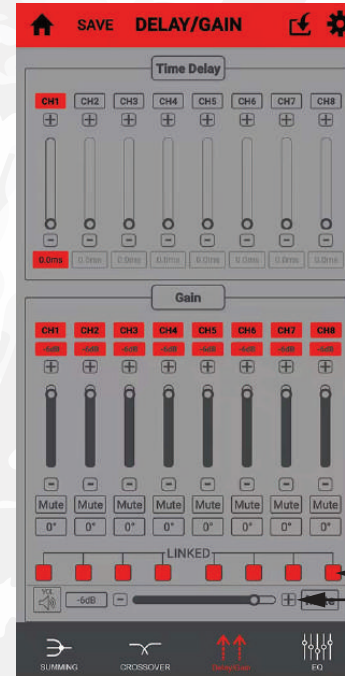
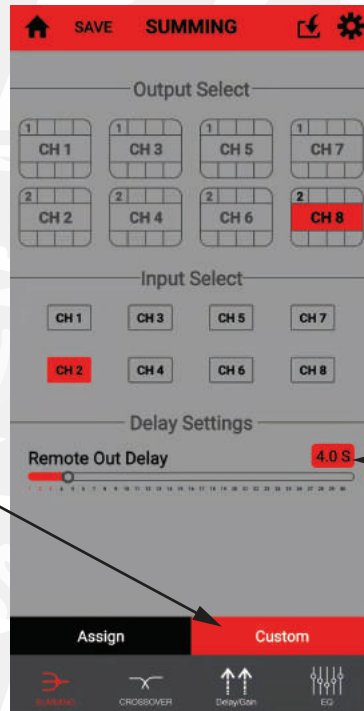

DELAY/GAIN PAGE PRE GAIN SETUP?? What? YES!
With ALL amplifier(s) OFF (or speakers disconnected) DO all PreSets. First..set GAINS on the DSP88 "GUI" (Graphical User Interface). I tend to be safe about this and set ALL channels at -6dB down as well as Master Gain. This still gives you 12dB of GAIN adjustment at the end. Easy way to do that is click the LINKED boxes at the bottom of each channel.

Now just slide one of the channels gain setting down to -6dB. Too easy!
All Channel gains are adjusted in one SWOOP. Do the same to the MASTER Volume -6dB. Thats the slider near the bottom of the page. You have a MASTER Mute button too!

Once that is done...lets move on to the CROSSOVER PAGE-VERY IMPORTANT!!!! Here you need to "PreSet" Crossover settings. This is SUPER important if you dont want to blow up your expensive speakers!

ALL Speakers on a HD motorcycle audio system MUST be highpassed - **PERIOD!!!! 99% of the time these are high output "Pro Style" speakers with high Fs (free air resonance) Make sure to HP (High Pass) at 80Hz or higher on any 6.5 Inch "Full Range" drivers.**

DOING ANYTHING ELSE will cost you time and money, and Heartburn!! YOU'VE BEEN WARNED!!!!

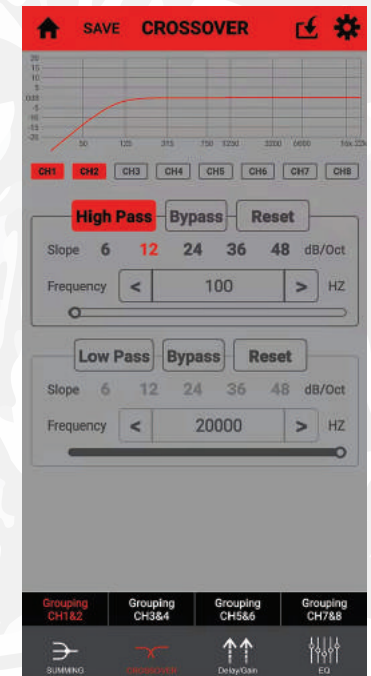

SPECIAL NOTE: SOME BIKES NEED LONGER THAN 3 OR 4 SECONDS FOR TURN-ON TO NOT POP AND BANG. USE THIS TO ADJUST THAT - UP TO 30 SEC!!!

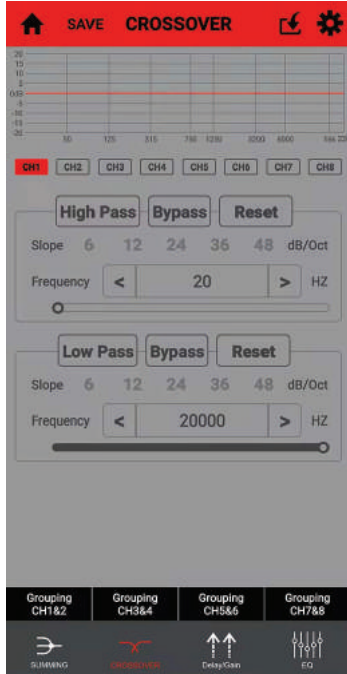

CROSSOVER PAGE

This is where you will HP you speakers (or Low Pass - LP for subs) SIMPLY “TAP” the HIGH PASS box, it will turn ORANGE if it is “Activated”. Once activated select crossover slope. 6/12/24/36 or 48dB slopes are available to you. I recommend a 12 dB slope. You can pick any slope you like. Then “TAP” the frequency box (the one that shows 20 in the middle).

Once you tap that - the keyboard window opens up - SEE BELOW

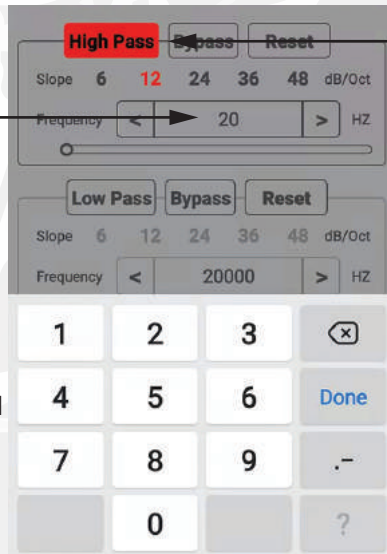

Once you have highlighted the 20(as shown to the right) go below and type in whatever frequency you desire, A good frequency to start with is 80Hz. Remember that these settings can all change anytime you want them too! So it isn't forever. Just your initial “PreSet Up”. Once you've type in whatever frequency - hit Done and it will show up in the Frequency “box” and you'll see it in the frequency response curve at the top of the page too.



NOTE: Looking to the left you will also notice that ONLY CH1“box” is activated (Orange)

NOW IF you want both Left/Right to be crossoverd over at the same frequency go to the bottom of the Crossover Page... and GROUP

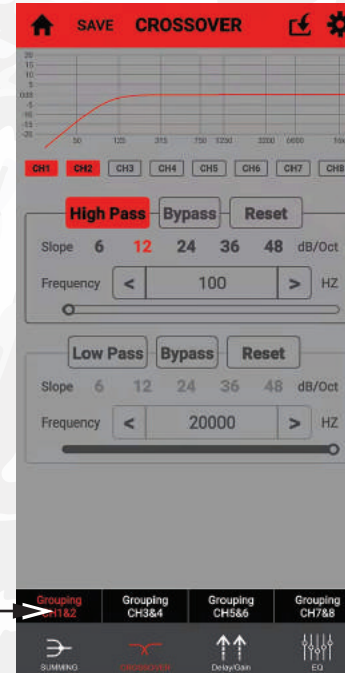

GROUPING

Grouping is a wonderful thing!(did I hear “orgy” in the background???... Oh...not that type of grouping...Damn!!)

Anyway....this is a cool function to speed up things and to keep it all together.

Typically you would want to make both the front fairing speakers crossover at the same frequency...logically. So the easy way is to “group” CH1/CH2 - meaning Left Front and Right front.

Simply “TAP” the Grouping CH1 & 2. A new window opens. The window below, “TAP” CH1. The window will blink out and CH1 and CH2 are now “grouped” so whatever crossover you've selected is for both CH1 and CH2

Too EASY!

HIGH PASS/LOW PASS/BAND PASS?

Highpass is ALWAYS used for Mids/Midbass and tweeters. Lowpass is ALWAYS used for woofers/subwoofers. Bandpass? Ahh.. that can be used for a lot of things. For example you could use it in a 3 way system (like a car) with Tweeters up in the “A” pillars, Midbass in the doors and Subwoofer in the trunk. A VERY common 5 channels system. But on a bike? You could use the bandpass feature for a “woofer” (NOT a subwoofer!) Subwoofer (a REAL one!) on a bike is ..well...DUMB in my opinion. Too much road noise, bike is too loud, very small enclosures and the desire to have HIGH SPL. ALL contribute a really BAD deal!!!

BUT ...bandpass a serious woofer (higher Fs than a sub!) And now ya got something!!!

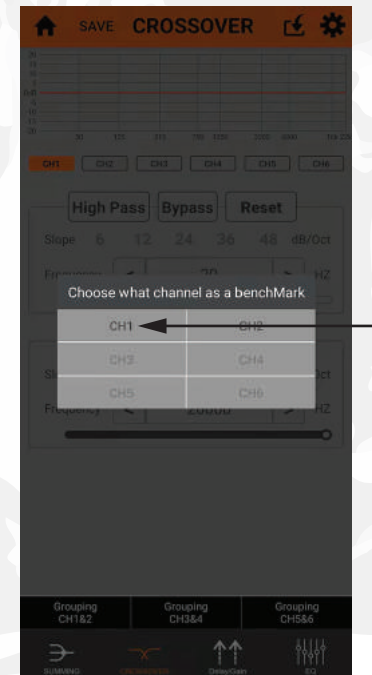

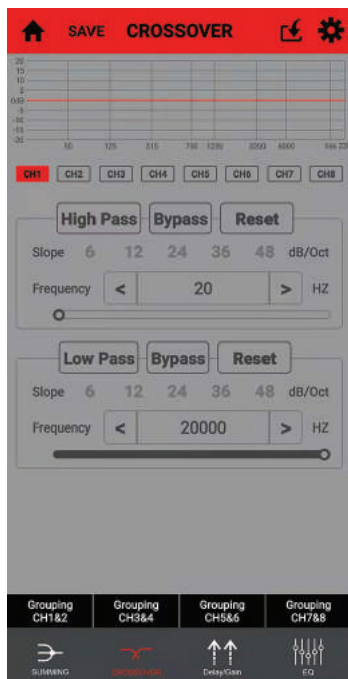

BANDPASS?

High Pass is ALWAYS used for Mids/Midbass and tweeters. Low Pass is ALWAYS used for woofers/subwoofers. Band Pass? Ahh.. that can be used for a lot of things. On a bike with a Processor that has 8 outputs (Gee? Like a DSP88??) ...High Pass the 4 channels that drive all the High Pass drivers (probably CoAx horns or High output Midbass drivers with horn tweeters.) And then BandPass CH5/6 to a monoblock or BIG stereo amplifier to some knarly Pro style Midbass drivers that go low. Thats not normal by the way. So hunt those baby's down. Need something with a High Fs (like 45-50Hz) and realitively high sensitivity. (over 95dB 1W/1M) Then CH7/8 can be dedicated to woofers (typically BANDPASSED)

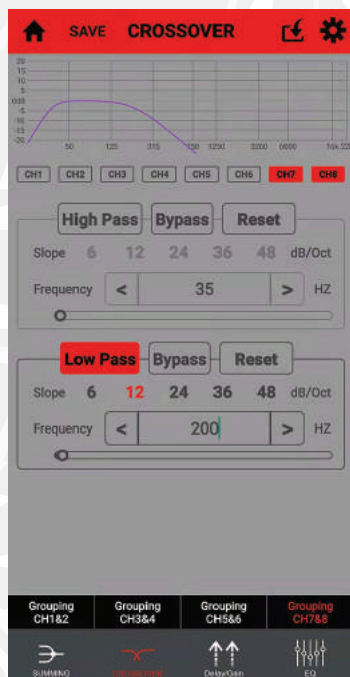

BAND PASS - HOW TO CREATE?

Sohow to create? Simple! Highpass plus a Lowpass equals a BAND PASS. Look at the settings on the CROSSOVER page to the right. I've selected High Pass on the top filter and selected 35Hz (basically I made a subsonic filter here). Then on the bottom filter I selected Low Pass. It is not highlighted..but it is activated...as you can see that I have selected 200Hz as the Low Pass. Look above at the curve and you can see the filter.

COOL huh!!

If you are using this for a “Woofers” on your bike then I would also recommend that you “GROUP” CH7/8. That way the settings are on both channels.

SPECIAL NOTE: TO REMOVE A CROSSOVER SETTING SIMPLY TAP & HOLD RESET FOR 2 SECONDS



HOW TO SAVE ANY SETTING?

This is SUPER important. ALWAYS save settings!!! Once you select SAVE on ANY page it will bring you to the “Save” text box as shown to the left. This is where you name the file so you know which one it is,

Once named. It goes back to whatever page you were on. IF you want to set this as your setting, then go to the TOP of any page and TAP this symbol  This will “Load” it to the processor can sometimes take up to 60 seconds,so be patient.

YOU KNOW THE SETTINGS ARE BEING “LOADED” WHEN YOU SEE THIS ORANGE MOON

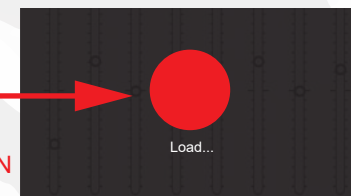

BEFORE you see the bright orange loading dot. You'll get this page to the right that asks do you REALLY want to load this DSP settings file (DUH!!!) Hit YES (of course!) and the ORANGE dot comes up to mesmerize you.

You've falling asleep...you'll write me a check for a million dollars...whoops ..you woke up!)

Moving on....

Remember that ANY setting can be deleted... and at worst case you can go into settings, then at bottom of page and TAP “Reset DSP Tuning”.And your DSP88 will start off all clean and fresh, NO EQ, Crossover or Gain/ Delay settings.

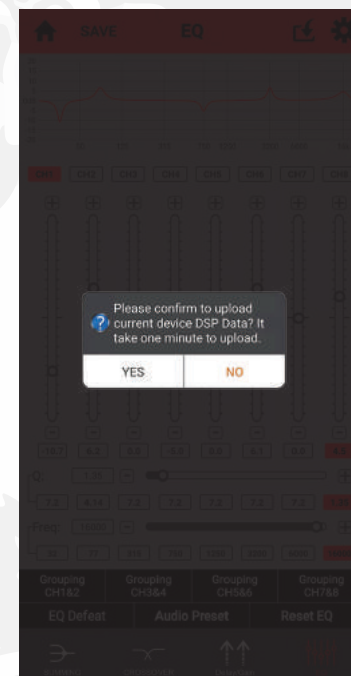

MORE COOLNESS!!

Another cool thing is you can instantly hear the difference in any and ALL of you memory settings you've saved!!! You can hear the difference between EQ settings, different gain settings, different time alignment settings.

All kinds of things.

So lets say you have one setting with a 80Hz 12dB slope High Pass filter on the front speakers?

Another setting has the crossover at 60Hz but at 24dB. Now you can hear what that difference sounds like. Just tap the one you want to listen to and it automatically switches to that memory setting

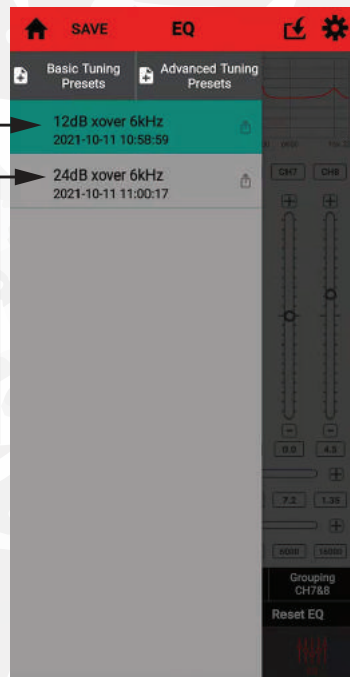

YOU CAN SHARE PRESETS!

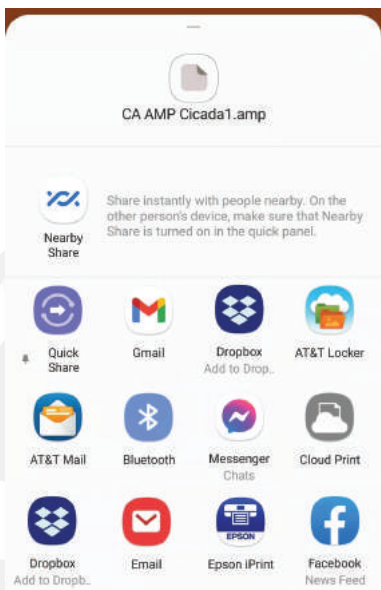

This is actually an advance settings thing- BUT while I am talking about what you can do with Pre Sets...you can SHARE them with your friends! Enemies, whomever.

Click the far right of one of the memory settings that shows the box with the up arrow. When you touch thatthe box on the left opens up (on Android at least)

From here you can pick how you want to send your file! Text, Email, whatever!!!

If you are copying a friends system and he has it all "dialed" up...you cans simply ask for his file and he sends it to you and BAMM! You're set up!!



With the DSP part pretty much finalized (at least for Pre Setting) WE now need to go to the amplifiers and do a "Pre"set gain adjustment on them. Again...the amplifier(s) is NOT powerered up and we haven't "Scoped" anything, metered...zip...zilich. But this works great and I have done it for over 10 years of doing DSP tuning. So lets just go with it, for now. Good news is you can readjust EVERYTHING once you get the system up and running

REMEMBER this is "Pre" Setup!

On ALL high pass channels - Pre Set GAINs to about the 10 O'Clock position. Remember that there is NO quarter gain. or half gain, or three quarter gain. No such thing. This "Pre" set is just that. A PRE set. Its just to get you on your way. ALL settings can me "massaged" and changed at any time

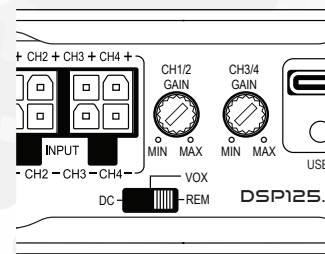

On ALL Low Pass channels - Pre Set GAINs to about the 12 to 1:00 O'Clock position. Typically bass needs more GAIN and more energy to keep up with the mids and highs. This "Pre" set is just that. A Pre set. Its just to get you on your way. ALL settings can me "massaged" and changed at any time

Now that gains and crossovers are ALL preset, inside the DSP and on the amplifier(s) it is time you've SAVED you settings on the DSP88 - ONCE SAVE is completed (it takes 60 seconds) its time to RECONNECT the amplifier(s).

1. Power everything DOWN - connect the amplifier now
2. Power everything up

Adjust your HU's volume to a comfortable level. You should have plenty of gain already. AGAIN this is NOT your final gains settings , or crossover or EQ (you havent even touched EQ yet ...RIGHT???)



EQUALIZER SCREEN (EQ):

This is where ALL the “magic” happens. There are 8 bands of Parametric Equalizer adjustments. Which means that YOU can select whatever frequency you need to fix, or bands of frequencies and easily solve the peaks or dips in your system setup. QUICKLY!

Q ADJUST:

Q (or width) of the frequency being adjusted. Q's of below 1 are very wide, Q of 10 is very narrow

FREQUENCY:

Each of the 8 Bands can be changed to ANY frequency you need it to be.

Click inside the grey box to the right of Freq: It will activate that frequency of that channel.

Type the frequency desired

NOTE: if you want this be the same for CH1/2 (for example) then go below and click **Grouping**

CH1&2 (or whatever CH you want to work with) That same window you saw before will “pop” open...then click whatever

channel you want to Group with. It will close and those channels are now grouped

NOTE: All “Q's” are set at 7.2 by default. You can move the slider to change “Q” also!

NOTE: Frequency can be “typed” You can move the slider to change frequency!

DOUBLE NOTE: IF you have't touched anything in a few seconds you may have to tap the slider you are adjusting to activate it again MAKE SURE - To TAP where you want the slider to be at,as the slider will move to where you TAP!!!

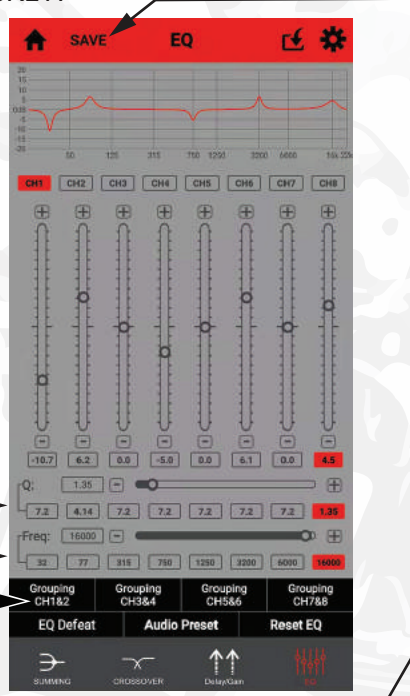

(Good time to SAVE and call it TEST1)

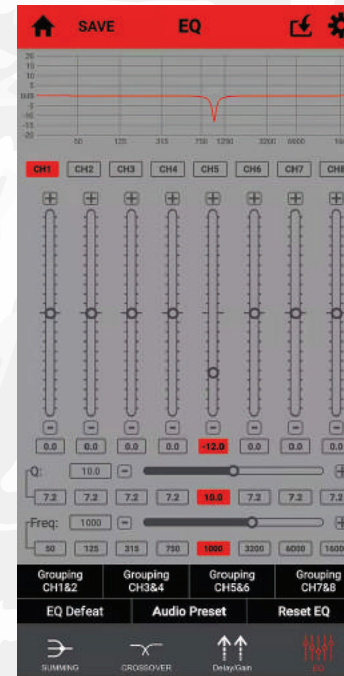
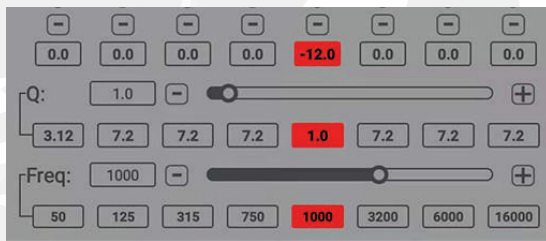

Q? what do I do with that? Lets play with this amazing EQ. There is so much you can do with very few controls and be able to EQ any speaker system very quickly. The beauty of “parametric”. You have total control of your sound.

EXAMPLE: To the left we have an EQ setting of 1,000HZ -12dB with a Q of 10. Notice how narrow this is. Very typical of what a 1/3 Octave EQ would do. Big issue with this is that it tends to be TOO narrow and not audible when you make that adjustment. All I am doing now is showing you how easy it is to adjust and what to touch and slide to make your life easier, and these adjustments meaningful. Even though Parametric is seemingly more complicated, in reality it is MUCH easier and quicker to EQ a system. But you REALLY need an RTA to do this!! NO BS!! Your phone can we a GREAT RTA. Download the app I told you about on page 5

Now look to the right at the SAME EQ setting as the above one same frequency, same amount of cut, everything. BUT “Q” is different. We went from a Q of 10 to a Q of 1.0 Notice the difference in the curve! You can hear that for sure!!! That's why Parametric is so powerful. Once you know the frequency you need to adjust (because your using an RTA to SEE where you need to be adjusting) then it really is a matter of playing with the Q and how much boost or cut you do. BUT Q makes the BIG difference.

Typically on a Bike you will adjust the front speakers almost identically. That's why you'll want to GROUP channels together to make it easier

SPECIAL NOTE: MAKE SURE TO ACTIVATE WHATEVER SLIDER YOU WANT TO MOVE AT THE TOP OF EACH SLIDER...NOT ON THE SLIDER ITSELF AS IT WILL MOVE THERE!!!

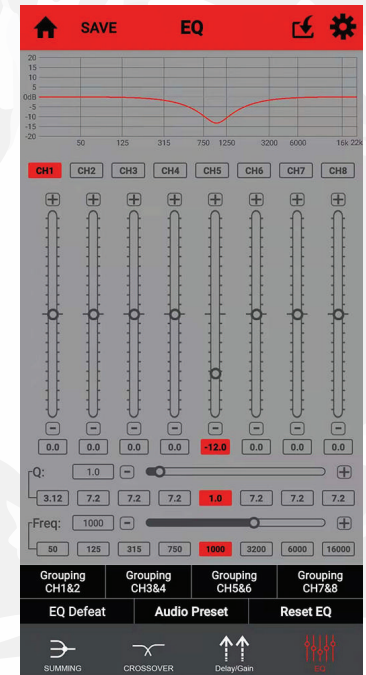

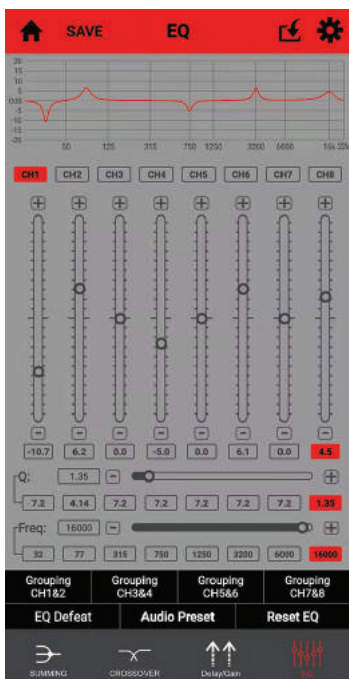

8 BANDS OF WHAT? PARA WHAT?

On our EQ you have 8 bands of PARAMETRIC EQUALIZER. ANY frequency and 8 bands of ANY Q and 8 bands of EQ of +20 /-20dB. In other words you have a LOT of EQ capability! Be careful what you do and know the limits of your drivers and amplifier(s).

HOW TO ACTIVATE ANY EQ BAND?

Simply "Tap" the band in the center. It will then ACTIVATE that band and you know it is because the grey boxes of that band turn RED. Now you can adjust that band and make it anything you want, any frequency, any Q, etc.

You'll notice that the band I picked (7...yeah Lucky 7) I've EQ'd +6.3dB at 6,000Hz with a Q of 6.3. Notice how narrow the "peak" is. You will hear this adjustment, one reason is it is in a band of frequencies that human ears are very sensitive to (2,000- 8,000Hz)

Now...notice to the right the SAME EQ setting, same frequency same amount of boost...BUT...different Q. Now we have a Q of 1. Notice the difference in the curve. You can DEFINITELY hear this difference.

For FUN....just move the frequency slider to the left or right

HUGE difference ! WOW! This is why I prefer parametric to 1/3 octave EQ's. Its easier to HEAR the changes you make. Easier to adjust.

Now if you think you screwed up (haven't we all!) just "Tap" and HOLD the Reset EQ tab and ALL EQ settings will be eliminated.

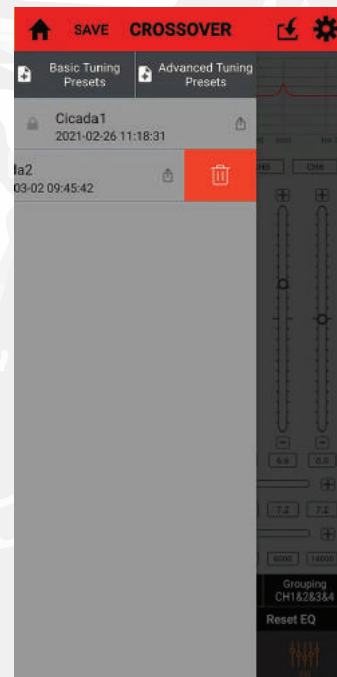
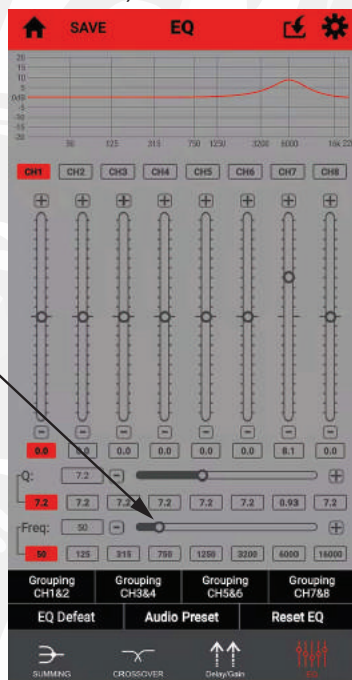

HOW TO DELETE A SETTING?

You can have up to 9 saved settings. But at somepoint your going to want to delete some. Here is how, its very simple. Go to the top of any page and "Tap" the SAVE link. That will bring you to ALL your saved settings. Press and hold the setting you want deleted and slide your finger to the left. You'll see the trash can in a red box. Tap that trash can...and its GONE!

REMEMBER THAT ONCE A SETTING IS DELETED IT IS GONE!!!!

Make sure to SAVE often. There is NO limit to how many memories you can save. You can always delete it (them?) later.

Lets go back to EQ settings

Now you've been playing around and you should have some sense of the system coming together audio wise. Is the level correct? Meaning do you have the ability to go to FULL power? Or does it sound like there is still more to get out of your system? Does it sound weird??

What IF you own a HD 2014-2020 and HAVEN'T "Flashed" you bike. IF you dont know what that is you should read up on it on our website. In a "Nut-Shell" HD has a "built-in" custom EQ setting in their stock OEM HD radio.

The STOCK HD EQ setting curve is shown to the right (in RED). The "Desired" curve is shown below that in GREEN. You can see that the stock curve is WAY off the desired curve. Have NO fear as Cicada is on it! We've designed into OUR software are own custom curves to flatten the HD curve!

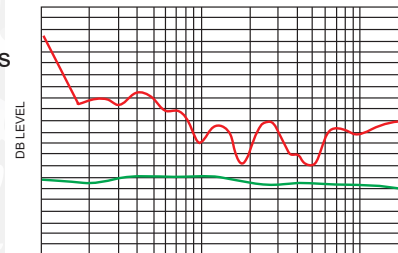

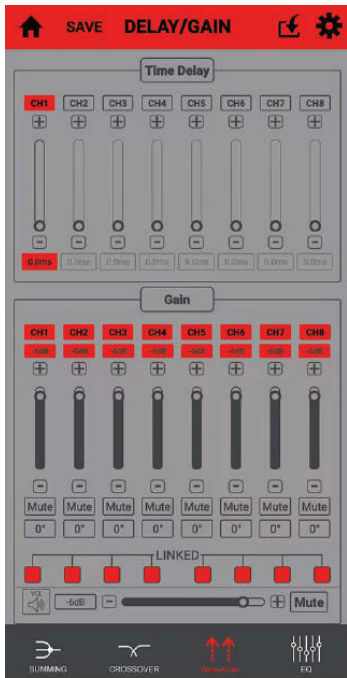

TO DELAY ...OR NOT!
Typically on motorcycles you won't be using DELAY(Time Alignment)

At least that is kind of the prevailing thinking with many HD audio guys.

But others think it is REALLY important. It's not the typical car audio time alignment. We aren't dealing with left and right being different path lengths - because we are offset in our primary seating positions - like a driver's seat. On a bike you are pretty much center. Buttime alignment FRONT to REAR is important.

And it can make a HUGE improvement in the overall sound quality on your bikes audio system.

SO...OO HOW MUCH AND HOW?

Good question! Lets look to the right and see the DELAY/GAIN page. You have your 8 channels lined up. Lets assume some things. You're using the DSP88 and 8 channels of amplification. Front channels (CH1/2) are driving the CH65.2 CoAx horn drivers. Rear Channels (CH3/4) are driving the CH69.2 Drivers. CH5/6 for rear Full Range. And then CH7/8 for woofers. We are going to concentrate on the front (CH1/2) is going to be are reference points. It isn't going to "move" time wise /Delay wise) So we select Rear (CH3/4) as those are the channels we will move TIME WISE (DELAY) Measure it from your seat, your ear to the speaker in the bag. Put that dimension in (*should be about 34 inches) But it needs be what is REAL,

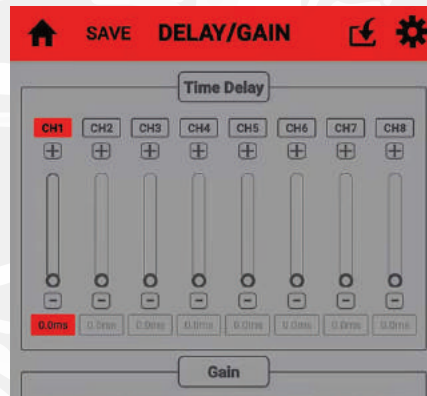

NOTE: You may want to delay your woofers too, That you'll do by ear, Unless you have SMAart Software. Yeah...dont think so.

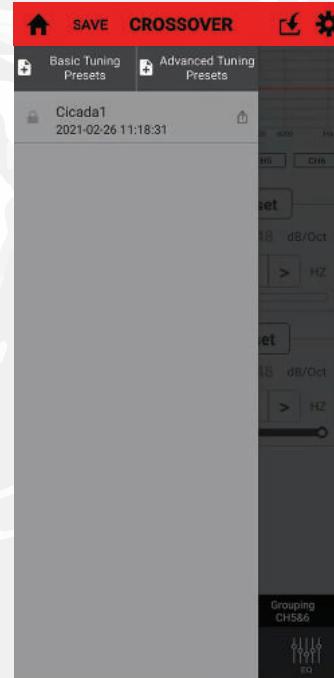

ONE LAST TIME FOR SAVING?

This is the last time you'll select SAVE! Whoop whoop! Again...you can do that from ANY page and once "Tapped" it will bring you to the "Save" text box as shown to the left. This is where you name the file so you know which one it is - like FINAL BIKE SETUP or something.

Once named. It goes back to whatever page you were on. IF you want to set this as your setting, then go to the TOP of any page and TAP this symbol. This will "Load" it to the processor can sometimes take up to 60 seconds,so be patient.

YOU KNOW THE SETTINGS ARE BEING "LOADED" WHEN YOU SEE THIS ORANGE MOON

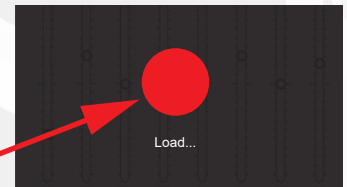

BEFORE you see the bright orange loading "moon". You'll get this page to the right that asks do you REALLY want to load this DSP settings file (DUH!!) Hit YES (of course!) and the ORANGE dot comes up to mesmerize you.

You've falling asleep...you'll write me a check for a million dollars...whoops ..you woke up!

Hey I had to try!! Moving on....

Remember that ANY setting can be deleted... and at worst case you can go into settings, then at bottom of page and TAP "Reset DSP Tuning".And your DSP88 will start off all clean and fresh, NO EQ, Crossover or Gain/ Delay settings.

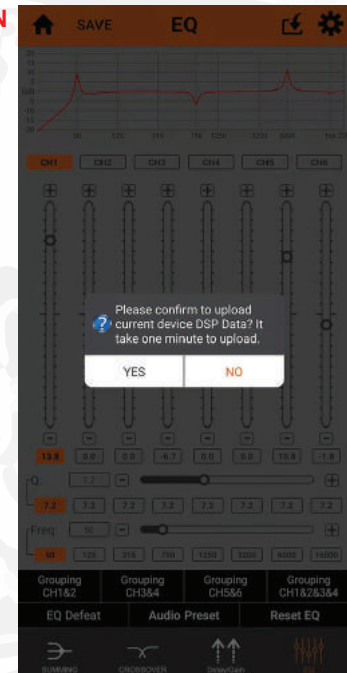

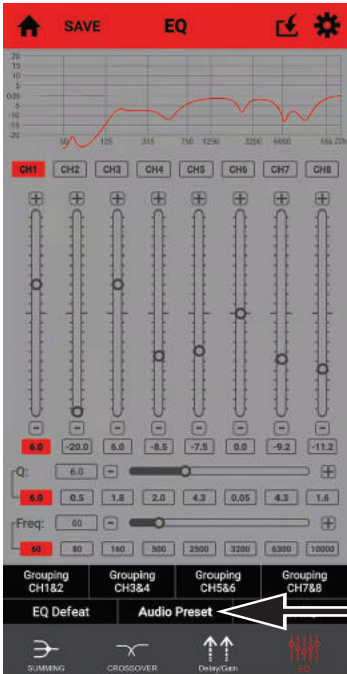

Since we know that HD put in their own strange custom EQ we have designed 6 Specific EQ, GAIN and CROSSOVER settings for YOUR system - with OUR product.

Select one of these “Audio Presets” and life just got a WHOLE lot easier!!

To the left I have chosen the PreSet “HD19 NEWER - HORNS” This is HD 2019 and newer bike with a 4 channels amplifier and front 6/5” speakers CoAx horns(or MidBass with Horns) and rear bag 6 X 9” CoAx Horn (or midbass driver and horn) Notice what looks like a strange EQ. This is done to compensate for HD’s CRAZY EQ!



This is ONE (1) of six “variations on a theme for EQing a HD audio system using Cicada Audio products, These ”PreSets are there to start you on your way. And NOT the “end all-be all” of curves!!! You will still need to do some adjustments. WE RECOMMEND that you do adjustments as everyone wants their bike to sound a certain way. There is NO correct EQ or “Perfect” EQ. Make sure to save your settings!!!

Try any of the other PreSets as you may like them even better.

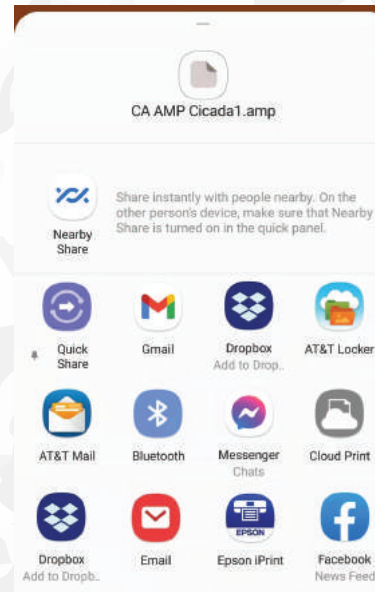

This is actually an advance settings thing- BUT while I am talking about what you can do with Pre Sets...you can SHARE them with your friends! Enemies, whomever.

Click the far right of one of the memory settings that shows the box with the up arrow. When you touch thatthe box on the left opens up (on Android at least)

From here you can pick how you want to send your file! Text, Email, whatever!!!

If you are copying a friends system and he has it all “dialed ” up...you cans simply ask for his file and he sends it to you and BAMM! You’re set up!!

ALMOST FINAL THOUGHTS

There is a lot to take in on setting up any DSP processor. The PreSetting of GAINS - both on the DSP and amplifier(s) is CRUCIAL. As well as PreSetting CROSSOVERS for ALL speakers in the DSP will make or break your system.

Also make sure ALL speakers are in PHASE. I forgot to mention that on the GAIN/DELAY page you can put each channel in and out of phase 180

This is SUPER important! You MUST have the system “In Phase” to be able to EQ it correctly

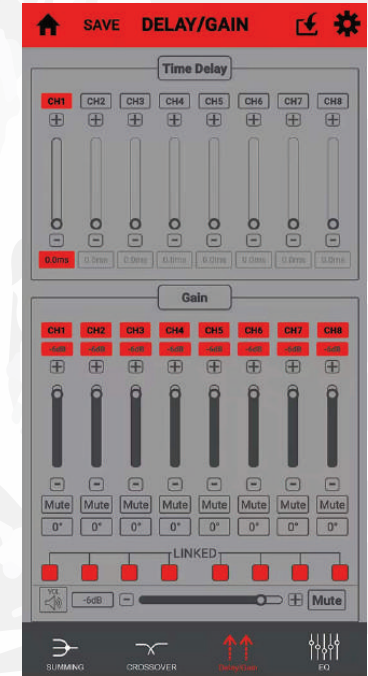



At this point you are pretty much done, My recommendation is that you live with the intial setup for a week and THEN make adjustments.

Also do not spend to much time “tweaking” the system. Once you have gains set CORRECTLY and have Checked “Phase” acoustically (with a Phase Meter - which is built into the AudioTools APP) Spend LESS than 45 minutes EQing your system.

Then take a break as your ears and brain will be charcoal!!

Rest your ears over night and listen again in the morning.

45 minutes is plenty of time to get a system intially “dialed in”.

You need to “live” with it for a bit BEFORE randomly changing settings.

Remember to play the music YOU listen to and not some “Artsy Fartsy “Audiophile recordings that you NEVER listen to!

Also make sure whatever recordings you listen to are as “HiRes” as possible and NOT 128mps MP3’s!!!!

**IF YOU HAVE ANY ISSUES DO NOT
HESTITATE TO CALL ME!**

1-480-758-4394

THAT IS MY DIRECT LINE

**OR EMAIL ME @
larryf@cicadaaudio.com**

Cicada Audio warrants this product to be free of defects and quality workmanship for a period of Two (2) years from the original date of purchase. A receipt from an authorized Cicada Audio dealer is required for warranty claim. Product warranty starts on the day of purchase or no longer than three years from the date of manufacture.

THIS WARRANTY IS NON-TRANSFERABLE AND APPLIES ONLY TO THE ORIGINAL PURCHASER OF THE PRODUCT IN THE ORIGINAL INSTALLATION.

Should a manufacturing defect occur during the warranty period, Cicada Audio will repair or replace defective product with a product of the same or equivalent value and performance. Damage or failure caused by improper use is not covered under this warranty. Negligence, improper use, product modification, unauthorized repair, accident, acts of god, dealer misrepresentation and improper or inadequate packaging during return shipment will not be covered. Warranty is void if serial numbers have been removed or defaced.

HOW TO OBTAIN WARRANTY SERVICE:

In the event a Cicada Audio product should require service, you should return to your authorized Cicada Audio retailer. All claims must follow the guidelines listed above and be returned with a copy of the original sales receipt.

Product returned for warranty service must be freight prepaid, properly packaged, and clearly marked with the Return Authorization (RA) number issued by Cicada Audio. Products that are returned and are improperly packaged, do not have an RA number clearly marked on the package, or have never been issued an RA number may be refused upon delivery. Cicada does not assume responsibility for lost or mis-labelled products.

Repair or replacement under this warranty is the exclusive remedy of the consumer. Cicada Audio shall not be liable for any incidental or consequential damages for breach of any expressed or implied warranty on this product. Certain states do not allow the exclusion of limitation of incidental or consequential damages, allow limitations on how long an implied warranty lasts, so the above limitations or exclusions may not apply to you. This warranty gives you specific legal rights and you may also have other rights that may vary from state to state.

For factory service contact:

Cicada Audio
3757 E Broadway Road, Suite 5
Phoenix, AZ 85040
Phone: 480-887-8699

cs@cicadaaudio.com

website: www.cicadaaudio.com